

Wire Measurements on the LHC TDI Absorber

T. Kroyer, F. Caspers, AB-RF

Properties of LHC TDI Absorber (1)

- ◆ Tank length 5400 mm
- ◆ Flat beam screen with 330 mm width and 120 mm height
- ◆ 80 mm wide absorber jaws leave full 120 mm aperture when retracted
- ◆ Aperture for nominal “in” position 8 mm
- ◆ No contact fingers between the absorber jaws and the beam screen over the entire jaw length
- ◆ Measurements done on the full tank but without the tapered transition pieces

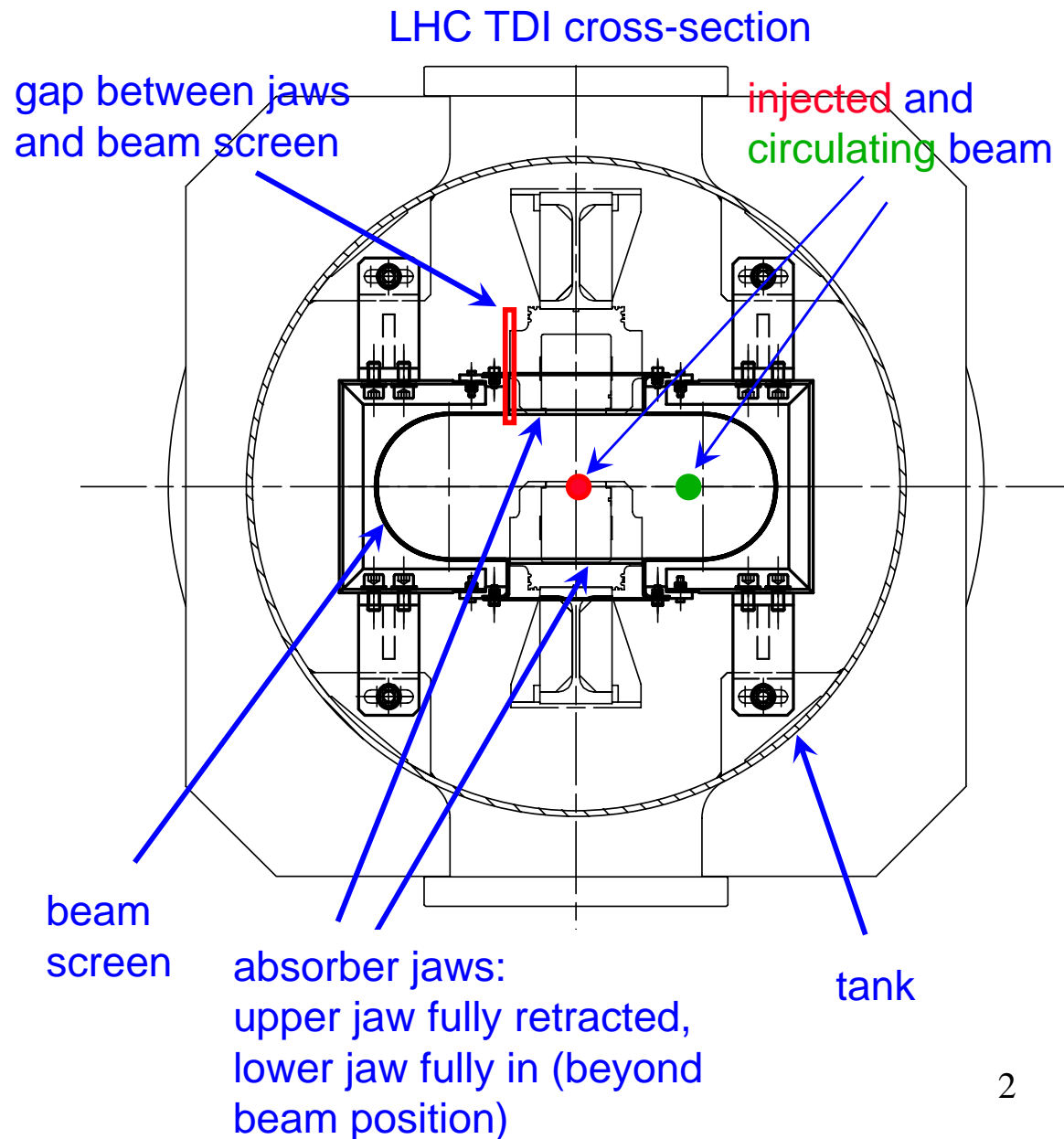

Properties of LHC TDI Absorber (2)

- ◆ The absorber jaws consist of 8 cells made from aluminium
 - Six 47.5 cm long cells holding Boron Nitride blocks (see picture)
 - One with copper absorbers
 - One with aluminium absorbers
- ◆ The total jaw length is ≈ 4.2 m
- ◆ The cells are fixed to the support structure in the center. There is a 5 mm wide and ≈ 90 mm deep gap between two adjacent cells

Front view

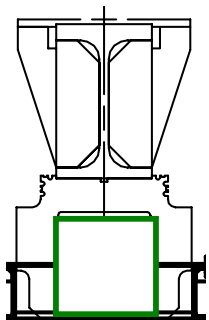

Cut of the absorber jaws along the beam axis - upper half of structure

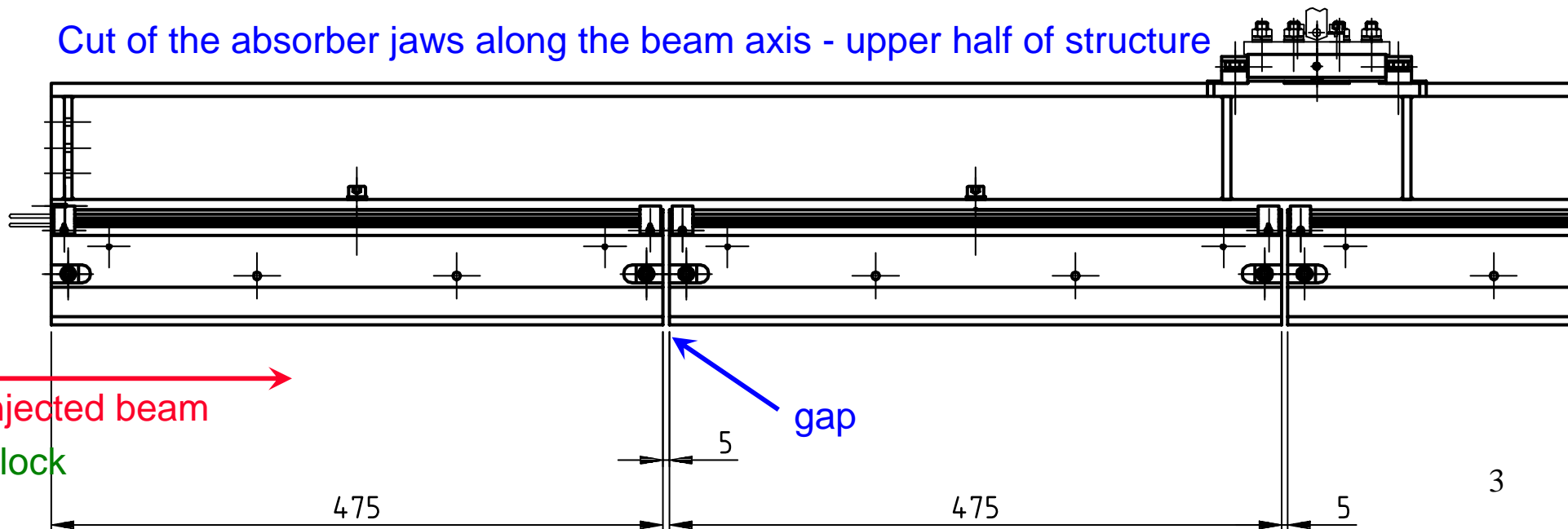

BN Absorber Blocks

- ◆ Material: copper, aluminium and hexagonal boron nitride [1]
- ◆ Boron nitride absorbers in 6 cells \Rightarrow they cover ≈ 2.85 m
- ◆ Each cell houses three BN blocks with a length of 15.7 cm each
- ◆ 4 μm Ti coating
- ◆ On the shoulders coating makes electrical contact to copper support structure
- ◆ No coating on the front and back side of each block and no well-defined electrical contact between adjacent blocks

BN absorber block beam

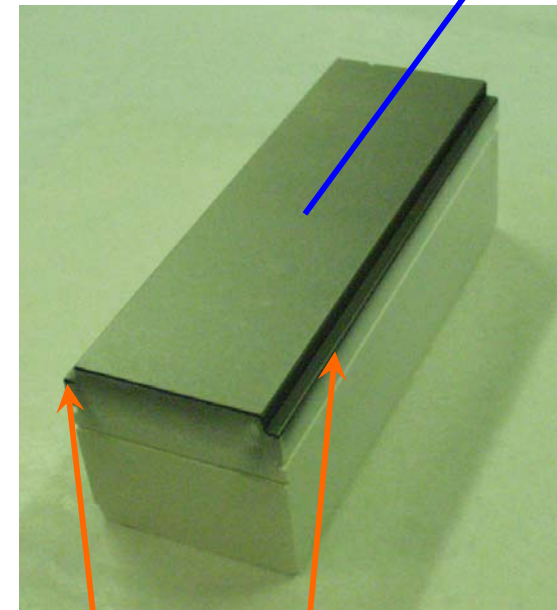

on both shoulders in contact with Cu support structure

[1] EDMS #448310 and #523643

Motivation for Measurements

- ◆ Simulations by Alexej Grudiev predict resonances of transverse modes on from the 30 MHz range. R and Q for the resonances below 100 MHz were determined in HFSS simulations, showing a significant transverse impedance [1].
- ◆ Above roughly 100 MHz full HFSS simulations become difficult due to excessive memory requirements. In addition, not all mechanical details of the tank can be included in numerical simulations.
- ◆ However, many more strongly coupled high Q resonances can be expected at higher frequencies from GdfidL time domain simulations. On this basis the installation of ferrites was recommended.
- ◆ Measurements are desirable to check the simulation results below 100 MHz and explore the resonances in the frequency range above, up to ≈ 500 MHz, where the LHC bunch spectrum starts to roll off.

[1] Grudiev, A, <http://ab-abp-rlc.web.cern.ch/ab-abp-rlc/Meetings/2006/2006.01.13/Transverse%20impedance%20of%20TDI.pdf>, 2006

Measurement Set-up

- ◆ A wire was used to simulate the **injected** beam; no measurements were done for the circulating beam as the impedance at this position is expected to be small
- ◆ As for simulations, the big tank length poses a big challenge for measurements. In order to keep the wire sufficiently straight, considerable tension must be applied.
- ◆ A tension force of ≈ 50 N was needed to limit the sag over 5.4 m to 1.2 mm on a 0.5 mm diameter wire.
- ◆ This is beyond the yield strength of copper. CuBe wire was used.
- ◆ In dependence of the jaw position characteristic impedance of the TEM line composed of the beam screen plus jaws and the wire varies between 340Ω (jaws fully retracted) and $\approx 100 \Omega$ (one jaw 1 mm from the wire).
- ◆ Matching resistors were chosen as 130Ω , corresponding to the 180Ω line impedance for the nominal symmetrical aperture of 8 mm.
- ◆ A perfect match is not very important when looking for sharp resonances...

Symmetric Aperture

- ◆ Measurements were done with the jaws fully retracted (120 mm aperture), nominal “in” position (8 mm aperture) and for intermediate cases.
- ◆ For the calculation of the longitudinal impedance, the CuBe wire attenuation was removed
- ◆ Losses due to internal mismatch are estimated ranging between 0.9 dB for full 120 mm aperture and 1.9 dB for 8 mm aperture \Rightarrow small compared to total measured loss
- ◆ Deep dips above 800 MHz probably due to $\lambda/4$ resonances of gaps between aluminium cells

Raw data

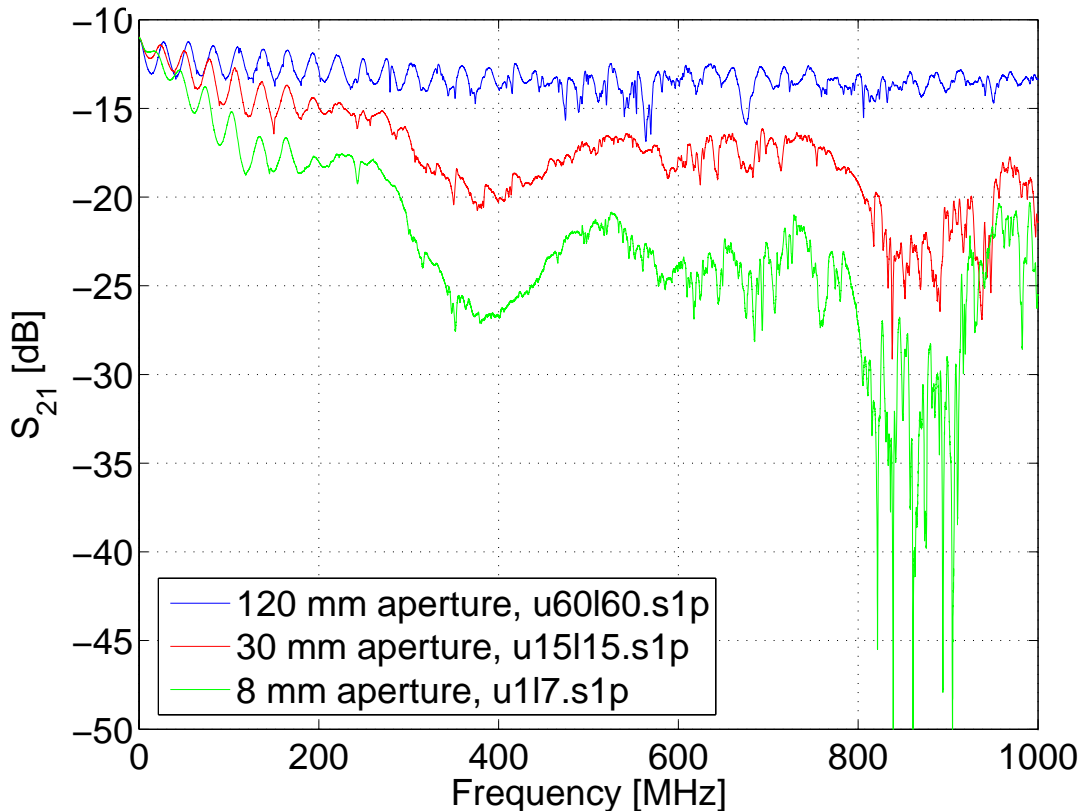

Longitudinal impedance

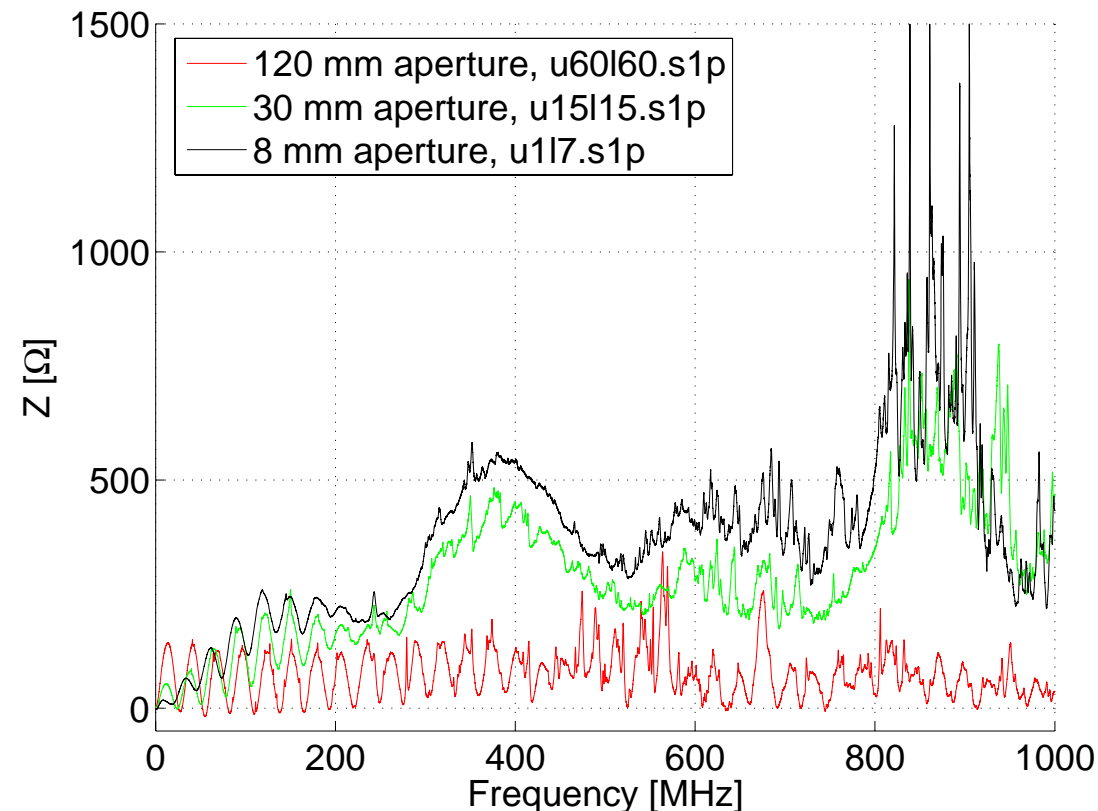

Transverse Sweep (1)

- ◆ The jaws were moved transversely with a constant aperture of 8 mm to observe transverse resonances
- ◆ The average electrical wire offset was found to be ≈ 2.7 mm
- ◆ Taking the calculated 1.2 mm sag the wire offset should range between about 2.1 and 3.3 mm
- ◆ This was verified by checking when the upper and lower jaw touch the wire
- ◆ For offset wire losses due to mismatch bigger than for centered wire; difference up to 0.8 dB (magenta trace), but small compared to observed amplitude offset (error $\approx 20\%$)

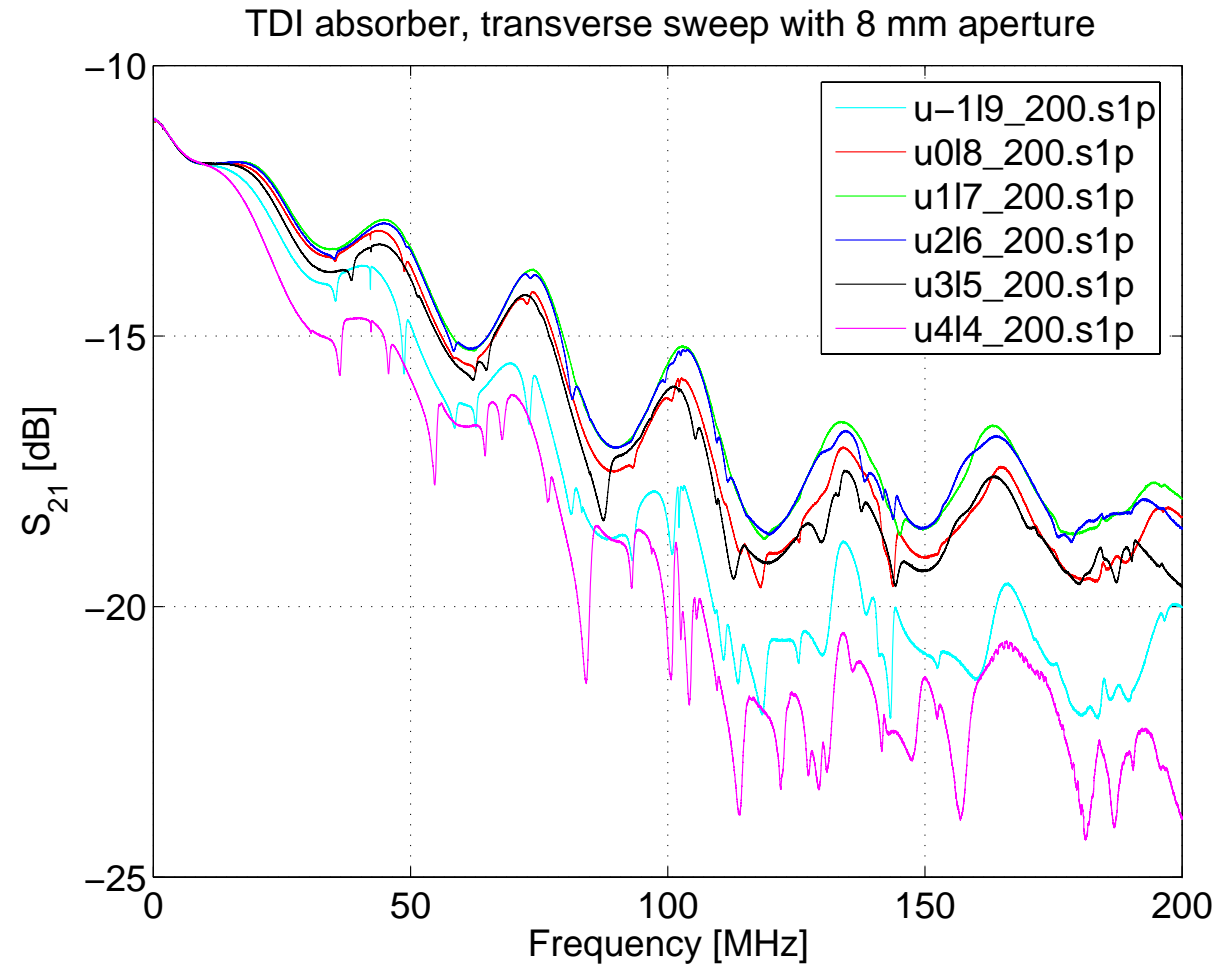

Transverse Sweep (2)

- ◆ As the jaws move off-center, dips from transverse resonances appear: we have an absorption resonator
- ◆ From the dip's depth the resonances' R can be calculated using the log formula as
$$R = \text{Re}(2 \cdot Z_0 \cdot \ln(|\Delta S_{21}|)),$$
with the line impedance Z_0 and the depth ΔS_{21}
- ◆ The unloaded quality factor can be obtained from
$$Q_0 = Q_L / |\Delta S_{21}|$$
from the measured loaded Q_L
- ◆ For small dips Q_L can be determined not at the 3 dB points but at fractional power levels [1]

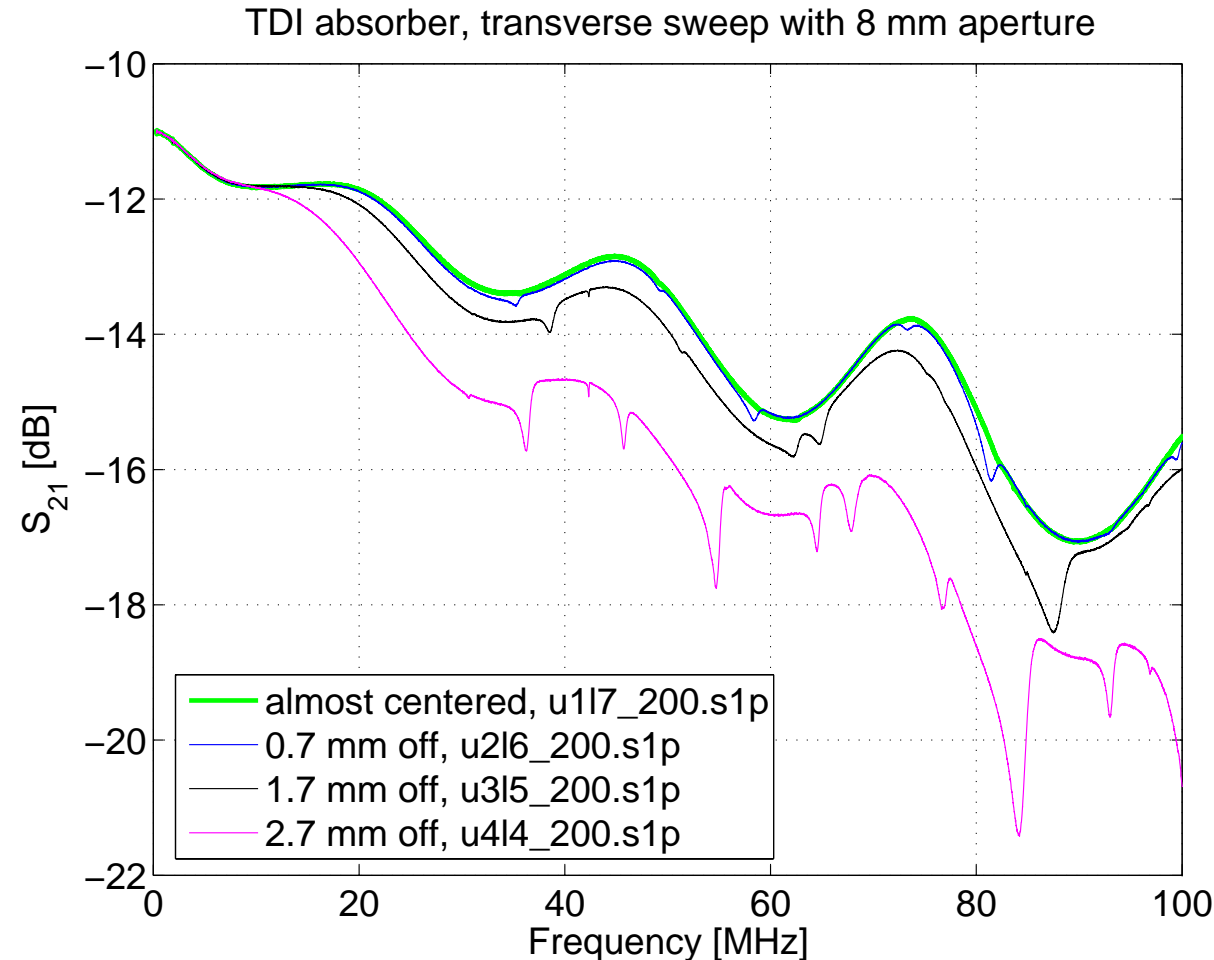

[1] Bray, J.R. and Roy, L., *Measuring the unloaded, loaded, and external quality factors of one- and two-port resonators using scattering-parameter magnitudes at fractional power levels*, IEE (2004)

Transverse Resonances (2)

- ◆ Even for the full 120 mm aperture a number of resonances were found
- ◆ In general the Q_0 are in the same range for symmetric and asymmetric apertures, but the coupling (R) is stronger in the latter case.
- ◆ The small wire offset could be the reason that transverse modes are also observed for symmetric apertures
- ◆ The strong peaks above 300 MHz could be due to longitudinal modes (?!?!)

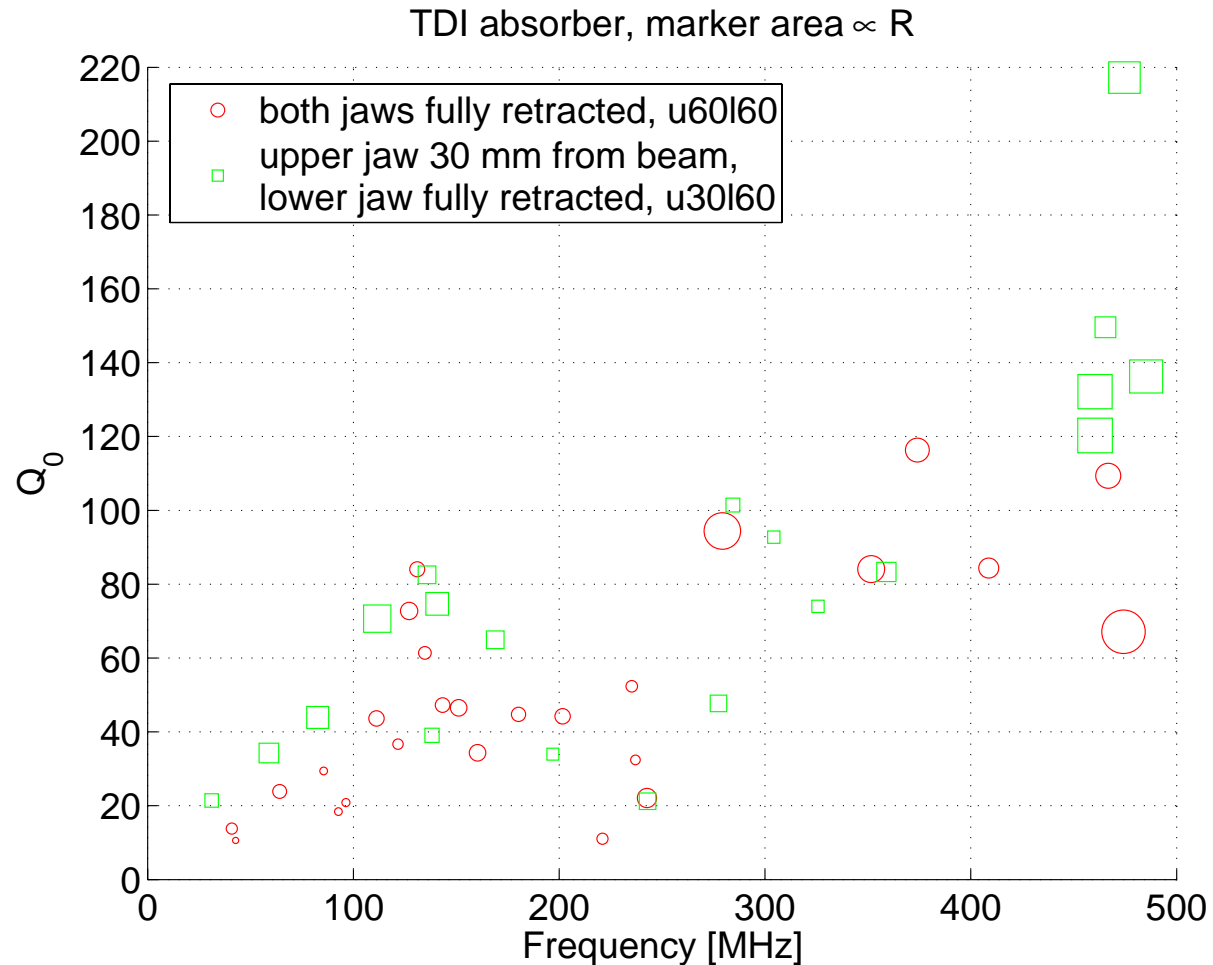

Transverse Impedance of Resonances (1)

- ◆ Longitudinal impedance plotted for different wire offsets with 8 mm aperture
- ◆ The resonance dips correspond to spikes in impedance
- ◆ From this transverse sweep Z_Y , i.e. the sum of driving and detuning transverse impedance can be calculated
- ◆ Taking a single point, for the $f = 84$ MHz resonance in the red curve, we have a $Z \approx 100 \Omega$ longitudinal impedance for $\Delta x = 2.7$ mm offset
- ◆ Z_Y then follows as [1]

$$Z_Y = \frac{c}{2\pi f} \frac{Z}{\Delta x^2} = 7.8 \text{ M}\Omega/\text{m}$$

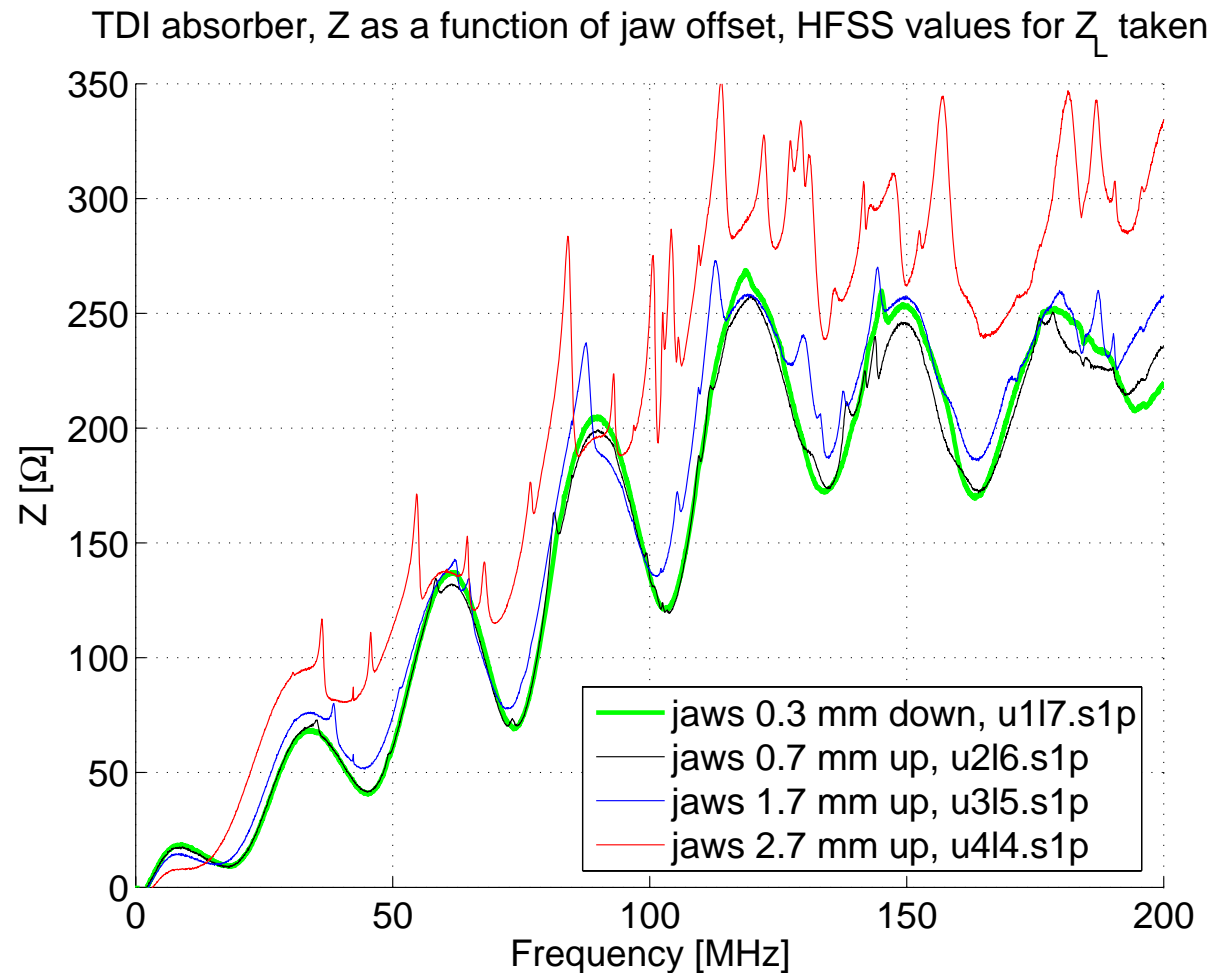

[1] Métral, E et al., *Kicker impedance measurements for the future multiturn extraction of the CERN Proton Synchrotron*, CERN-AB-2006-051; Geneva : CERN, 13 Jul 2006

Transverse Impedance of Resonances (2)

- ◆ For broad-band impedances Z_Y can be obtained for a given frequency range by fitting parabolas as a function of offset into impedance data.
- ◆ This is not easy for distinct peaks, since when the jaws are moved, the resonances are detuned. It is then not obvious which dips come from which mode.
- ◆ Therefore Z_Y was calculated for each position under the assumption that the resonances vanish when the wire is centered. For perfect parabolas all the curves should match.

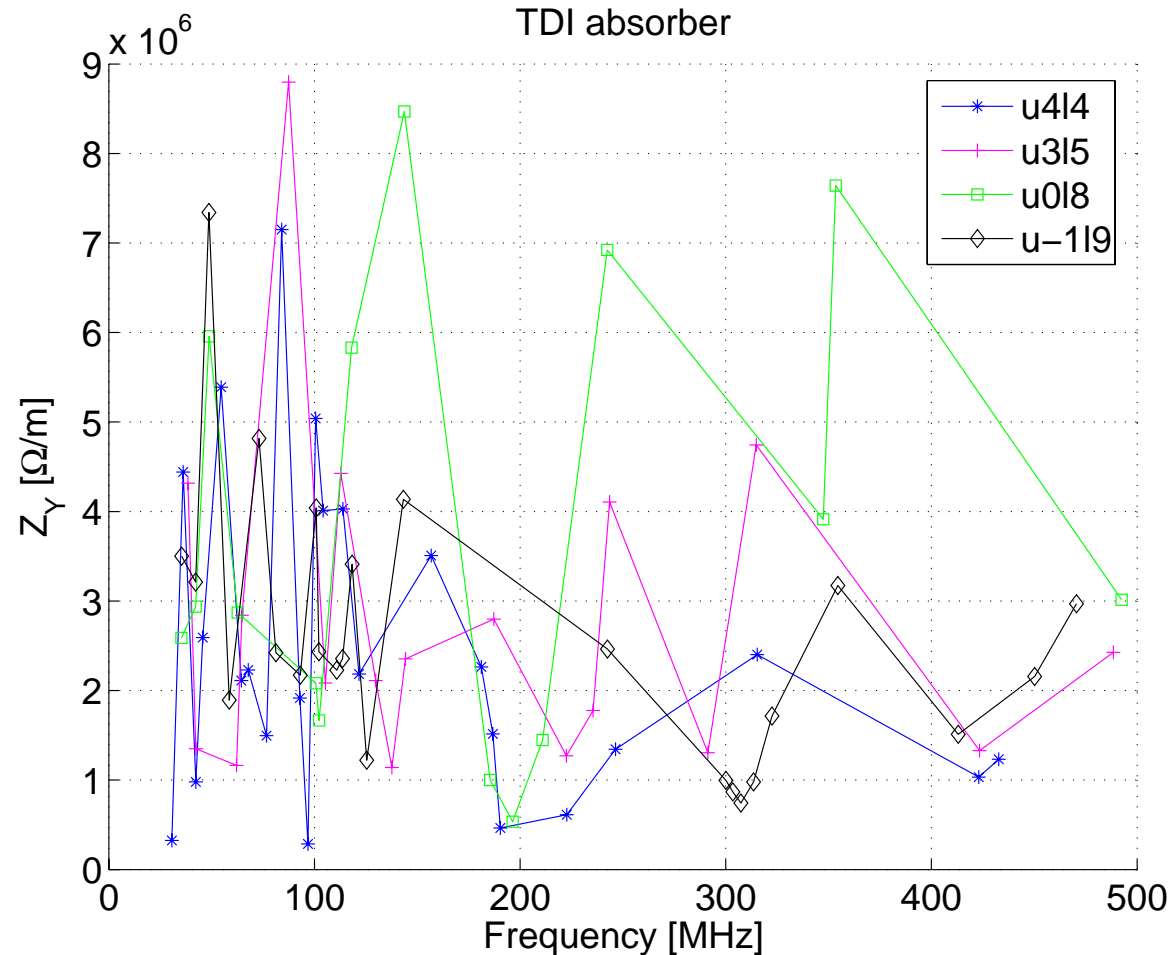

Broad-Band Transverse Impedance (1)

- ◆ Using the parabola-fitted technique the broad-band impedance was calculated for 8 mm gap
- ◆ In dependence of the input data set Z_Y may vary within almost a factor 2
- ◆ The two sets with the best fit quality are plotted here: all data (blue trace) and the two outermost points removed (green trace)
- ◆ At the position of distinct peaks the Z_Y values calculated for single resonances are found
- ◆ The 30 MHz ripple is linked to the ripple on the input data and the jaw position-dependent detuning
- ◆ Z_Y roughly between 4 and 2 M Ω /m between 0 and 200 MHz

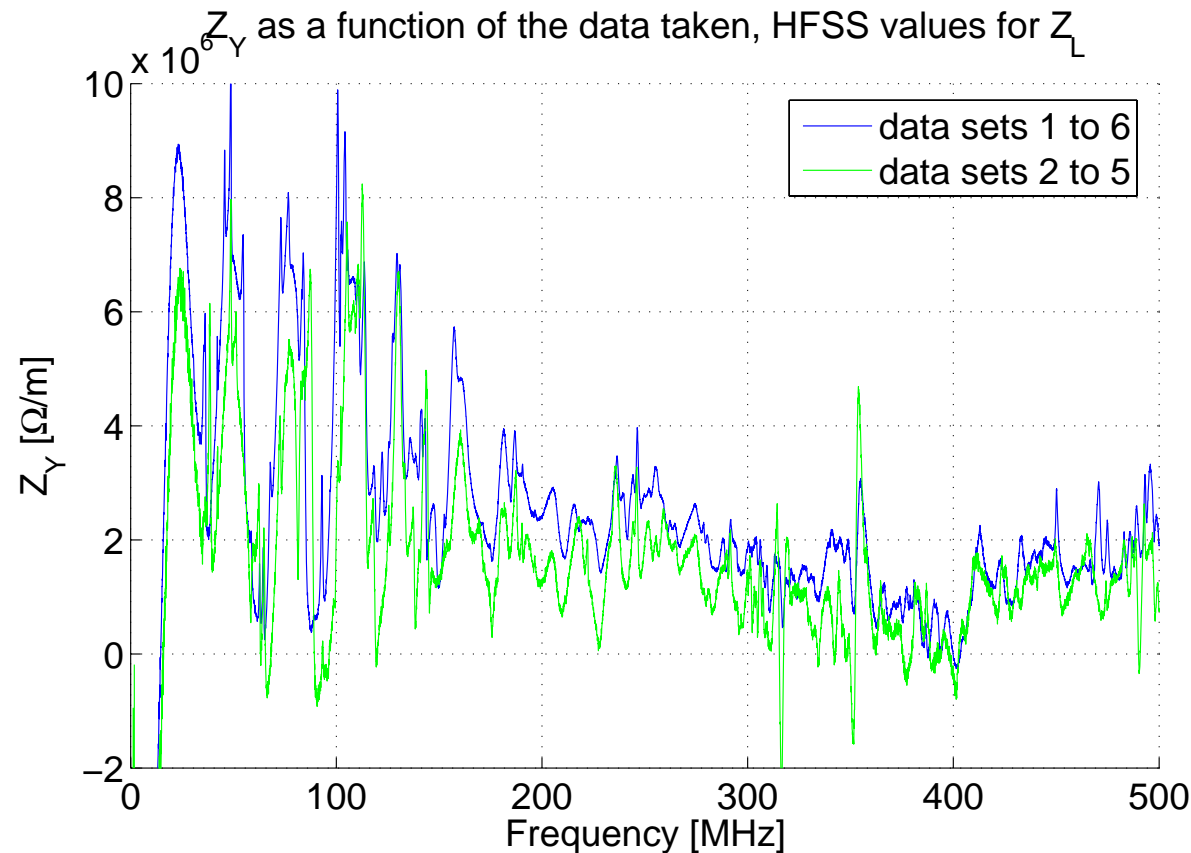

Broad-Band Transverse Impedance (2)

- ◆ After first measurements, the transverse sweep with 8 mm aperture was redone the following day with better frequency resolution
- ◆ Most of the measurement set-up, including the wire had to be mounted again
- ◆ The repeatability was found to be good, as illustrated by the Z_Y calculated from the full data set of each measurement
- ◆ However, this does not rule out uncertainties due to the dependence of the line impedance on sag and the impact of multiple reflections
- ◆ These uncertainties are hard to quantify; we may be within a factor 2

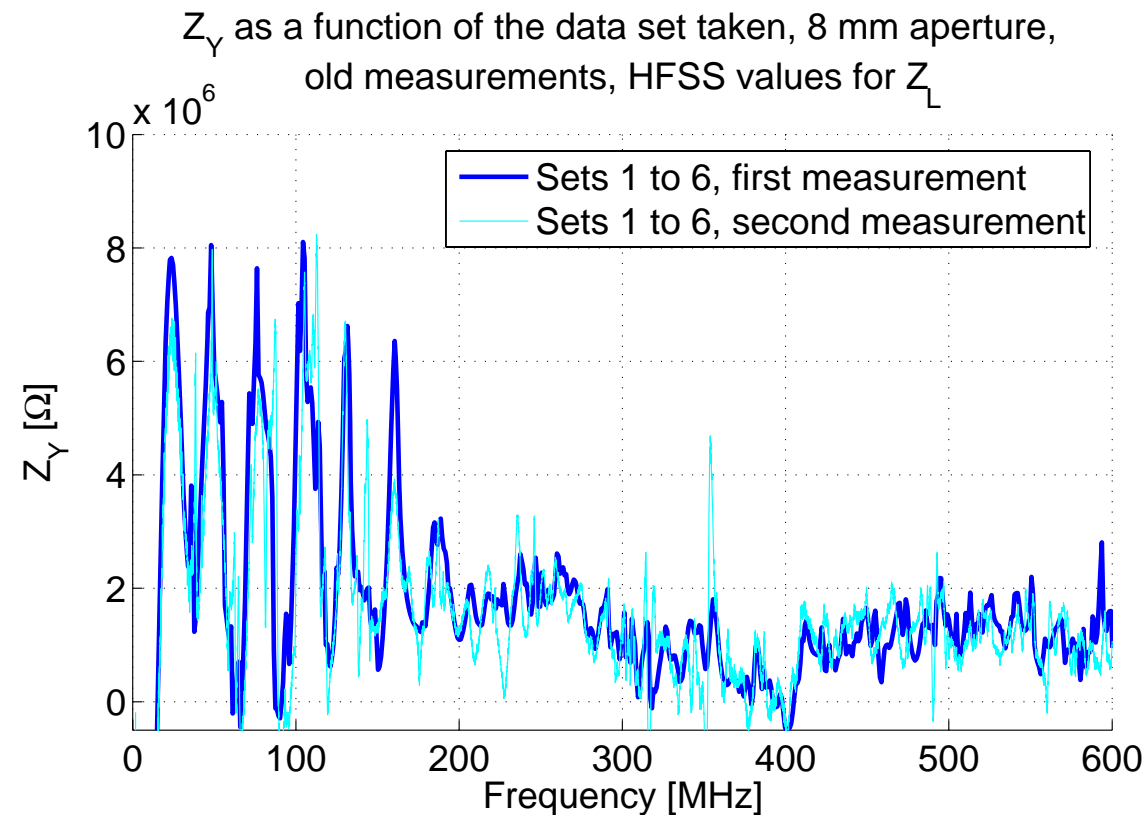

Broad-Band Transverse Impedance (3)

- ◆ One parameter for the fit quality is the peak of the fitted parabola. It should be more or less close to zero offset
- ◆ Offsets calculated in the fit differ by up to ~1 mm from expected values. Only at the position of resonances other values there are significant discrepancies. This points to a reasonably good fit quality
- ◆ The blue curve was obtained from all data, including these with the wire very close to the jaws. Therefore there are many more resonances, which affects the fit quality at many frequencies
- ◆ The fit quality was also checked visually at many frequencies

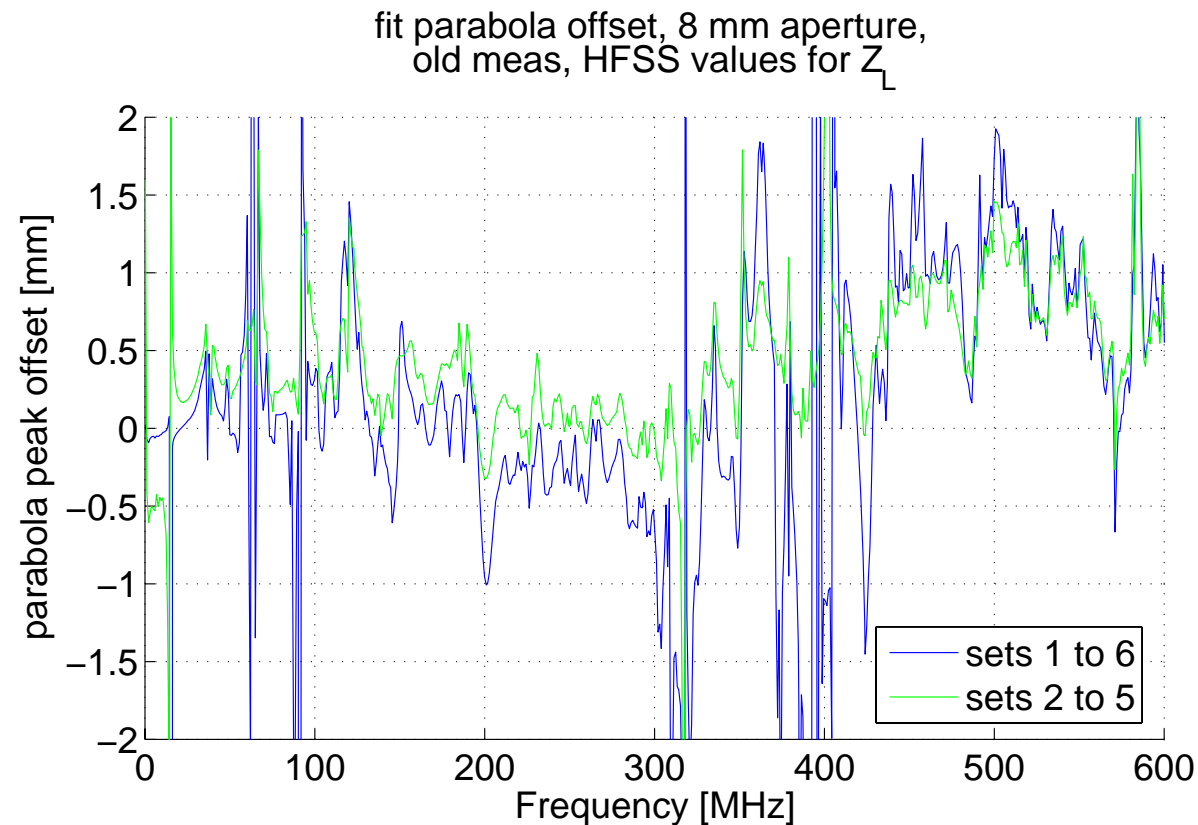

Broad-Band Transverse Impedance (4)

- ◆ Longitudinal impedance plotted for different wire offsets with 15 mm aperture

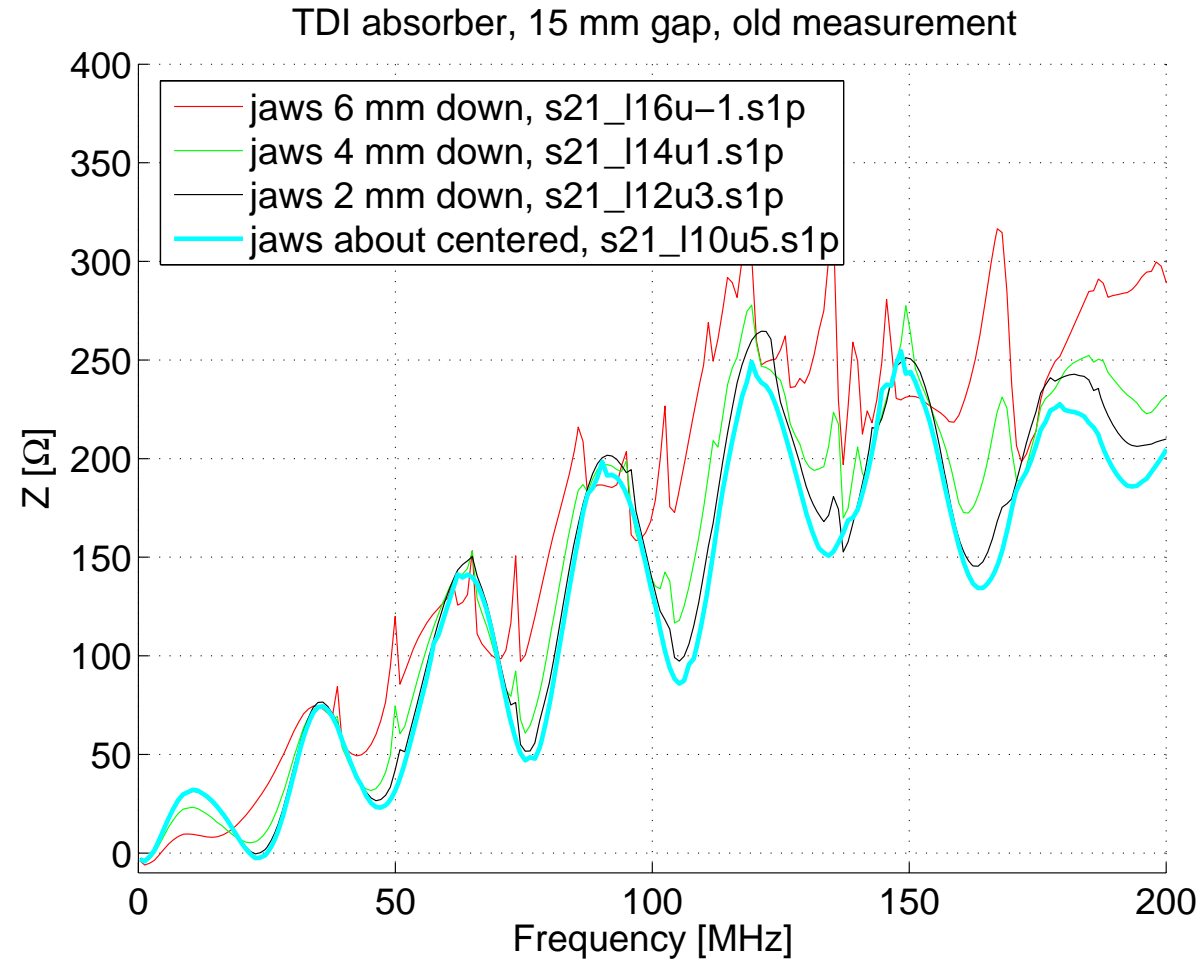

Broad-Band Transverse Impedance (5)

- ◆ The same evaluation was done for the transverse sweep with 15 mm gap
- ◆ Data was taken in 2 mm steps
- ◆ Two data sets with about best fit quality plotted
- ◆ Z_Y roughly between 0.9 and 0.5 $M\Omega/m$ between 0 and 200 MHz

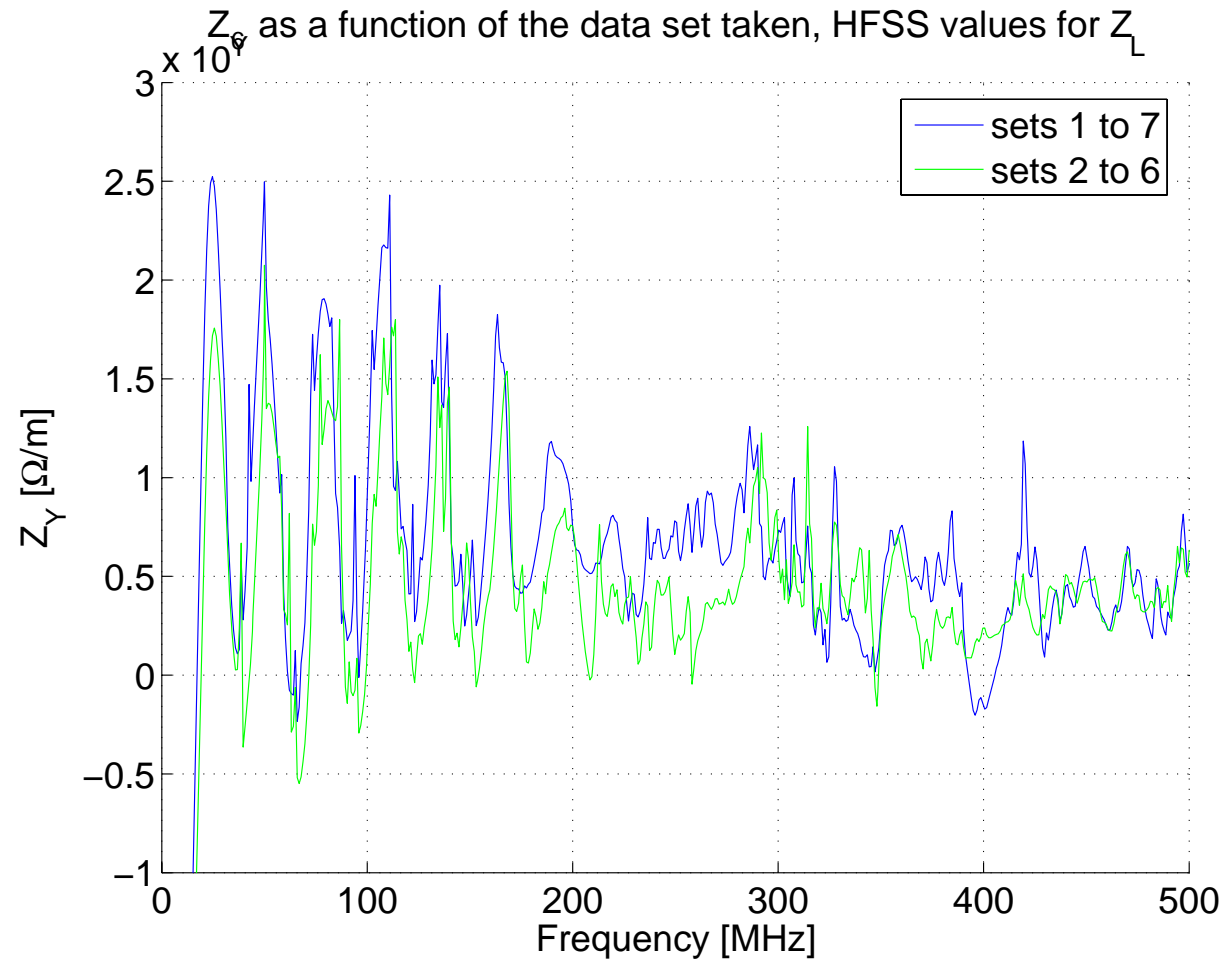

Broad-Band Transverse Impedance (6)

- ◆ Imaginary part of Z_Y for 8 mm gap

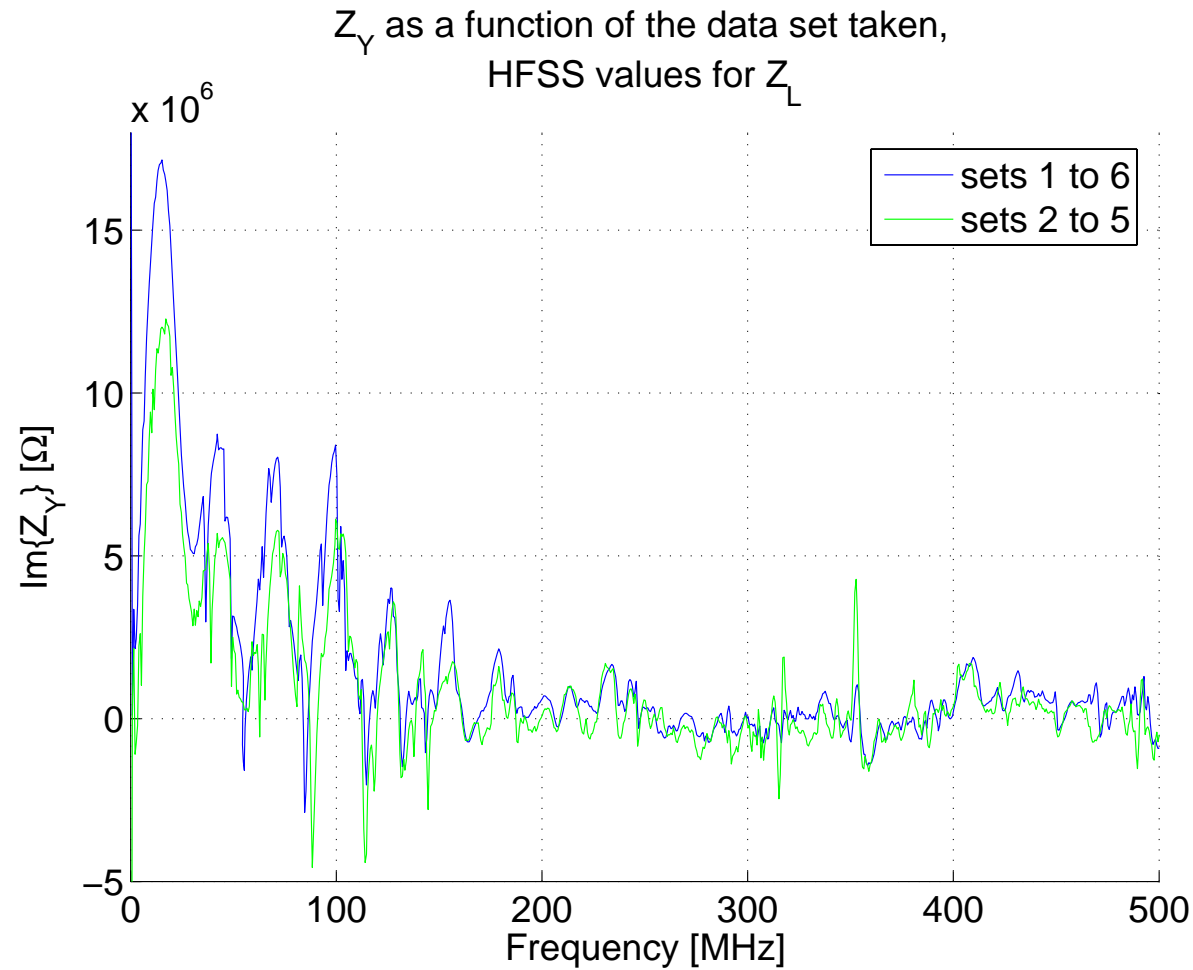

Bench Measurements

- ◆ One aluminium cell housing three BN absorber blocks was examined more closely in dedicated measurements
- ◆ Ordinary transmission measurements as well as resonator measurements were done
- ◆ The fully TDI assembly consists of 8 such cells, 6 of which house BN absorbers; the others house Al and Cu absorbers which should have low impedance
- ◆ The DC longitudinal resistance of the Ti coating was found to be $\approx 0.7 \Omega$ (0.32Ω calculated for ideal Ti conductivity)
- ◆ The Ti coating was applied a few days before the measurements. They were stored in a nitrogen atmosphere.
- ◆ For small gaps and high frequencies, most of the image current should flow close to the beam \Rightarrow effective impedance higher

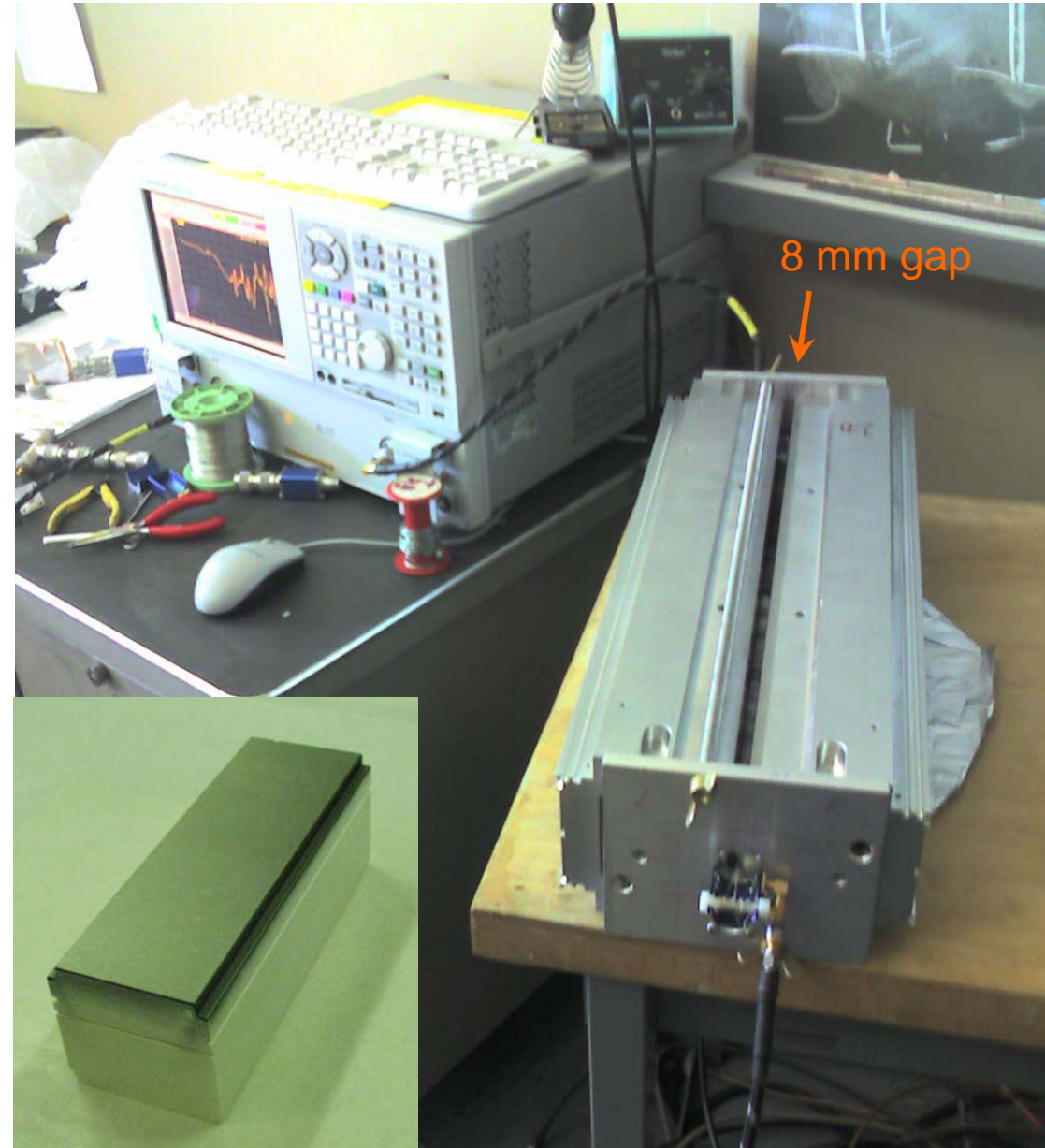

Transmission Measurements

- ◆ Matching done for 8 mm nominal gap
- ◆ Cross-check with aluminium structure with 8 mm gap showed good results (blue trace)
- ◆ Smooth curve for 8 mm gap (thick cyan trace)
- ◆ For bigger gaps there is a mild mismatch leading to bigger and bigger ripple. In these traces the dips should come close to true value of Z , provided the mismatch is small
- ◆ For too big mismatch even in the dips Z is overestimated

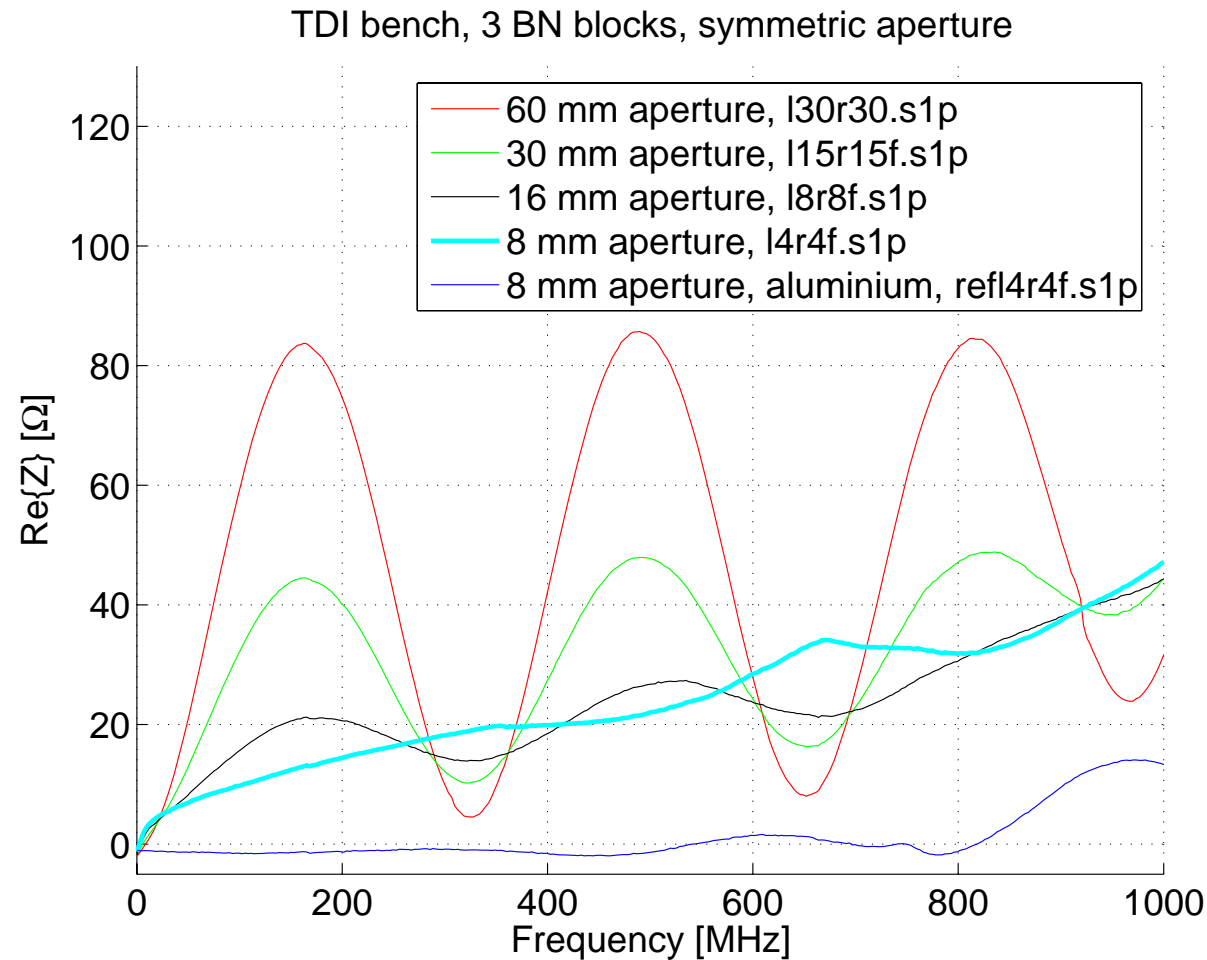

Resonator Measurements

- ◆ Small capacitive coupling used
- ◆ Sensitivity check with aluminium two-plane line yielded very small Z (blue trace)
- ◆ The resonator samples the line with a standing wave pattern. The set-up consists of three absorber blocks with not very good electric contact between. For resonances at multiples of three the current has its maximum at these junctions \Rightarrow the resonator does not see the contact resistance etc \Rightarrow only the Ti coating resistance is measured
- ◆ At the third resonance an impedance between 3.5 and 5.5 Ω was found, increasing for smaller apertures due to current concentration in the center
- ◆ The impedance at other resonances is much higher \Rightarrow block-block transitions have big impact on overall Z

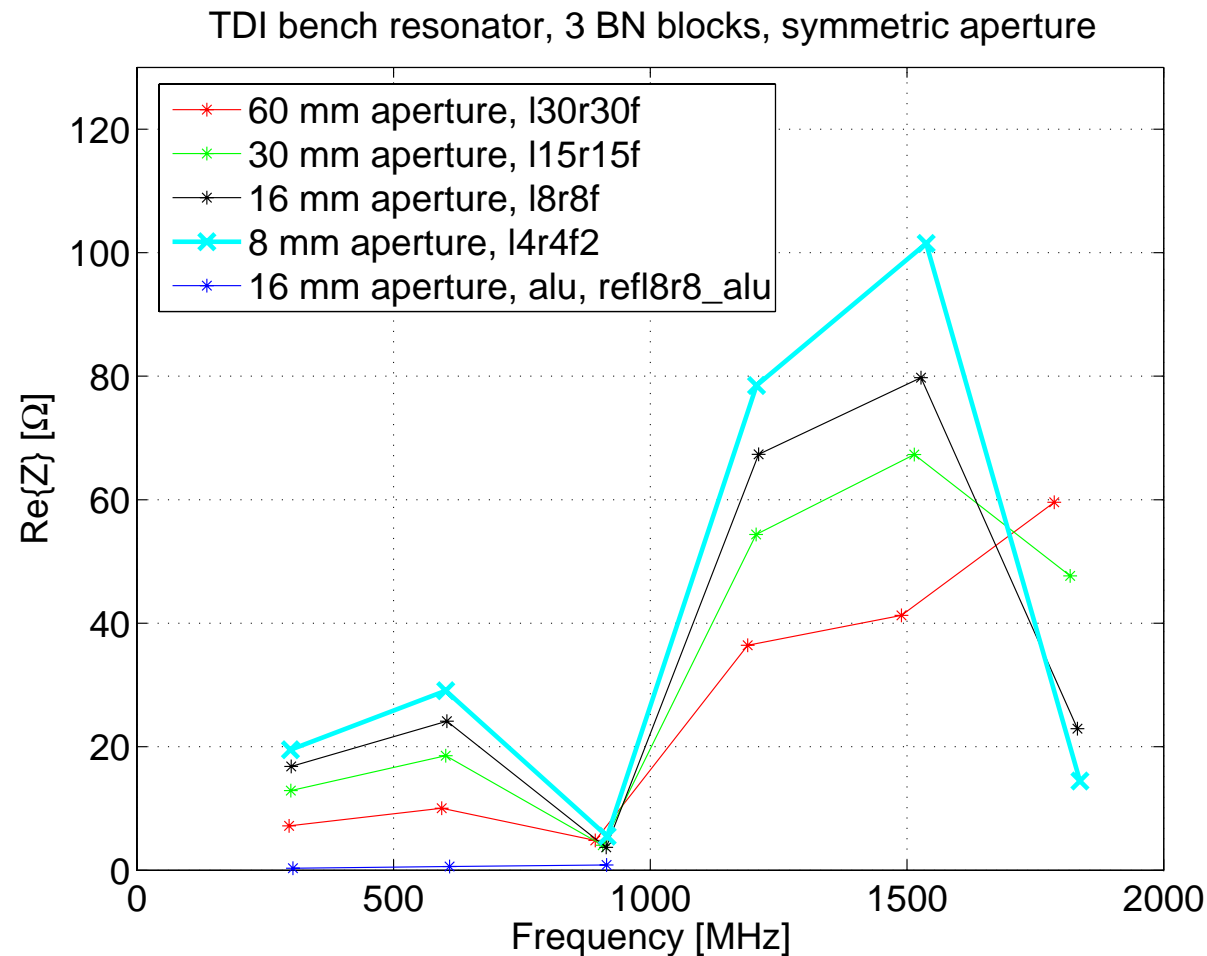

Transmission versus Resonator Measurements

- ◆ Comparison of transmission and resonator data shows good overall agreement
- ◆ As expected dips of transmission response come close to real Z
- ◆ Several major differences between the two techniques
 - Resonator does not see losses at the flanges of the set-up
 - For the first and second resonance the squared current density at the block-block transitions is 50 % higher than on average \Rightarrow impact of these two transitions higher
 - Transmission measurement gives pessimistic results when not perfectly matched

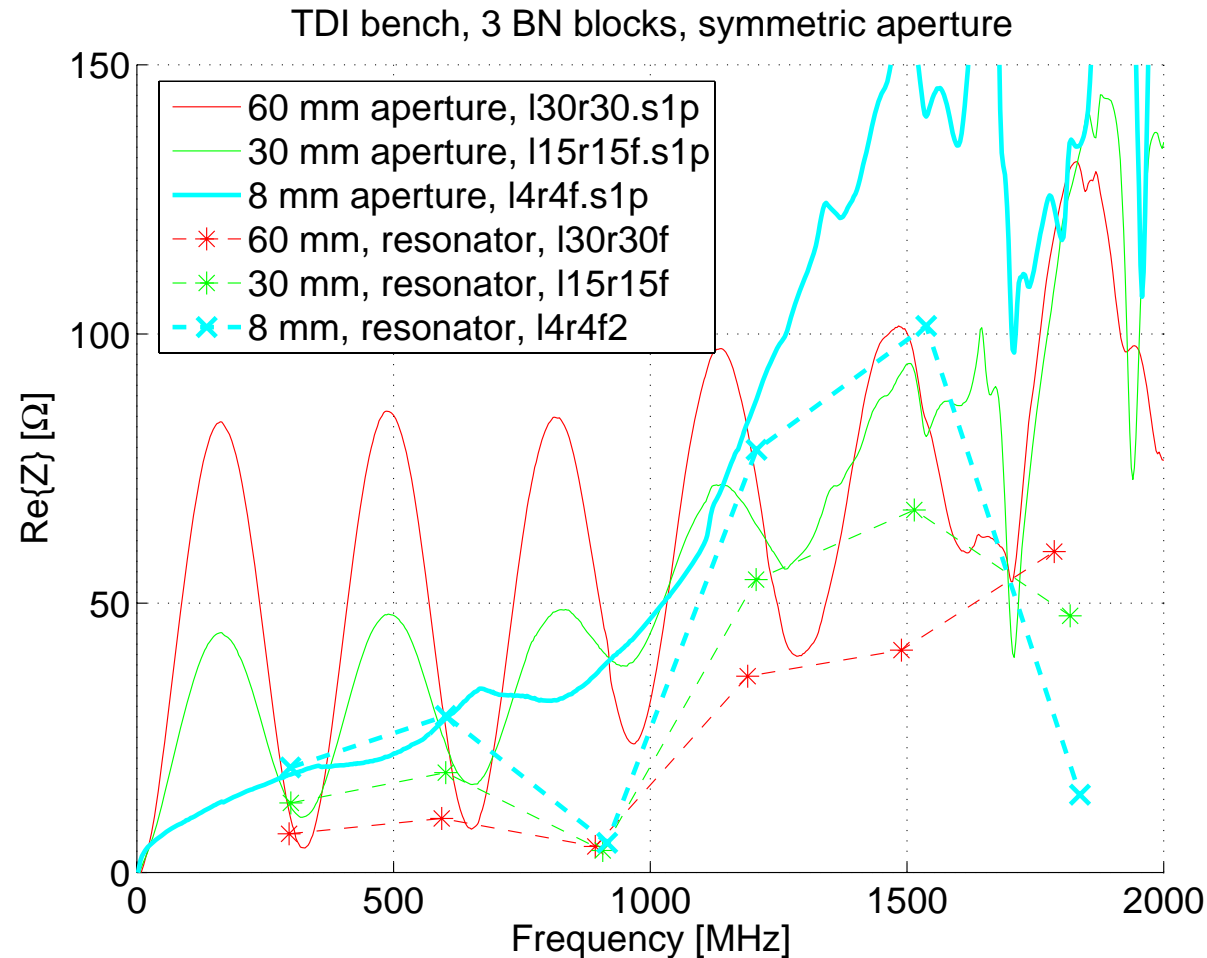

Transverse Sweep

- ◆ 8 mm aperture, offset ± 2 mm
- ◆ Measurement comes close to the method's sensitivity limit
- ◆ Good fit quality in particular around 500 MHz, where small values of $Z_Y \approx 35$ k Ω /m are found
- ◆ Scaling to the full BN absorber length a moderate $Z_Y \approx 200$ k Ω /m is obtained

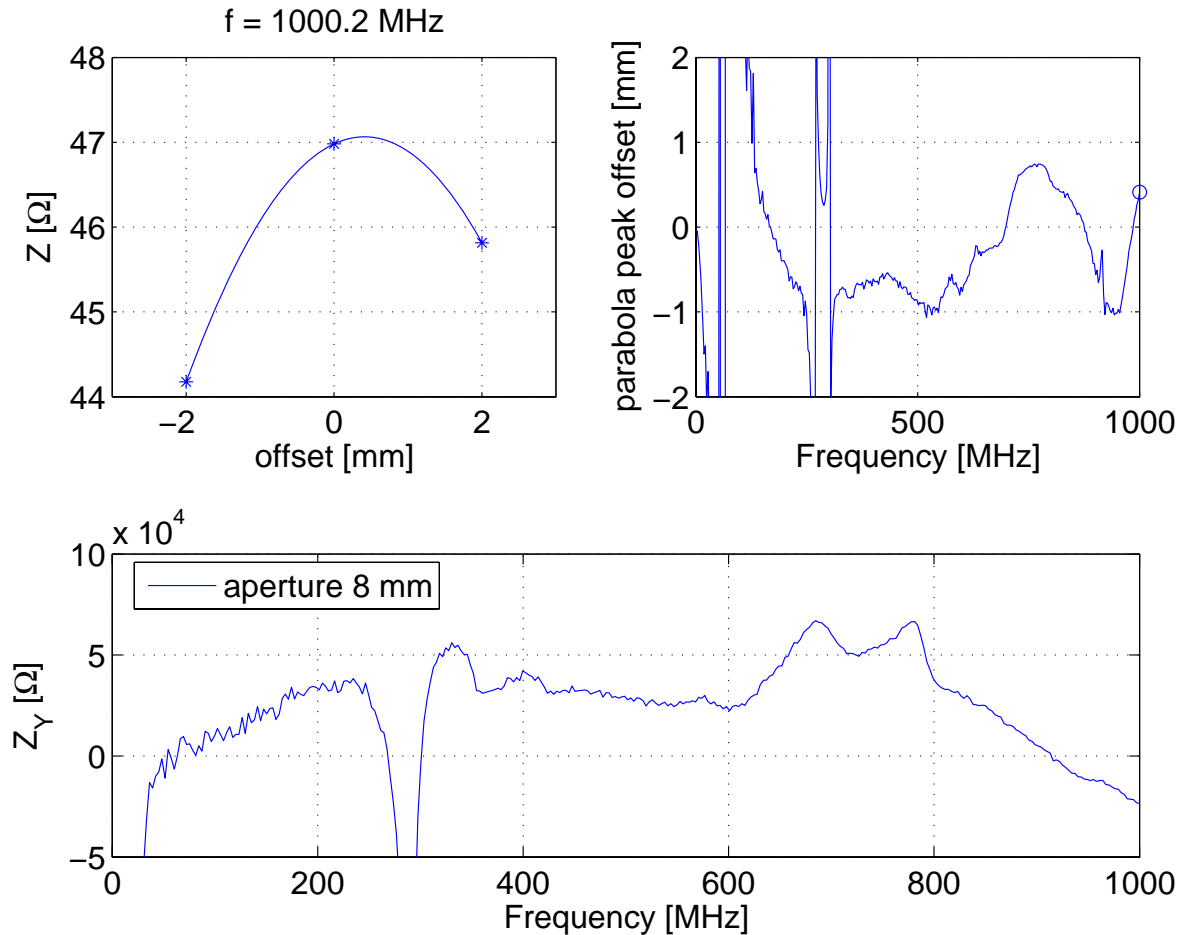

Bench versus Entire TDI - Z

- ◆ Comparison between Z of entire TDI absorber and up-scaled Z from bench measurement for 8 mm aperture
- ◆ Scaling done under the assumption that the TDI impedance is dominated by the Ti coated ceramic blocks; impedance of Al and Cu blocks neglected
- ◆ Bench measurement yielded much lower longitudinal impedance
- ◆ Larger measurement uncertainties for entire TDI, in particular linked to power loss from mismatched, but should not exceed 20% above 200 MHz
- ◆ Comparing the geometries of the bench set-up with the full TDI, two potential sources of impedance can be identified
 - Discontinuities between 50 cm absorber cells
 - End effects at the extremities of the jaws
- ◆ Ageing of the Ti coating on the blocks in the full TDI could also have affected their resistivity

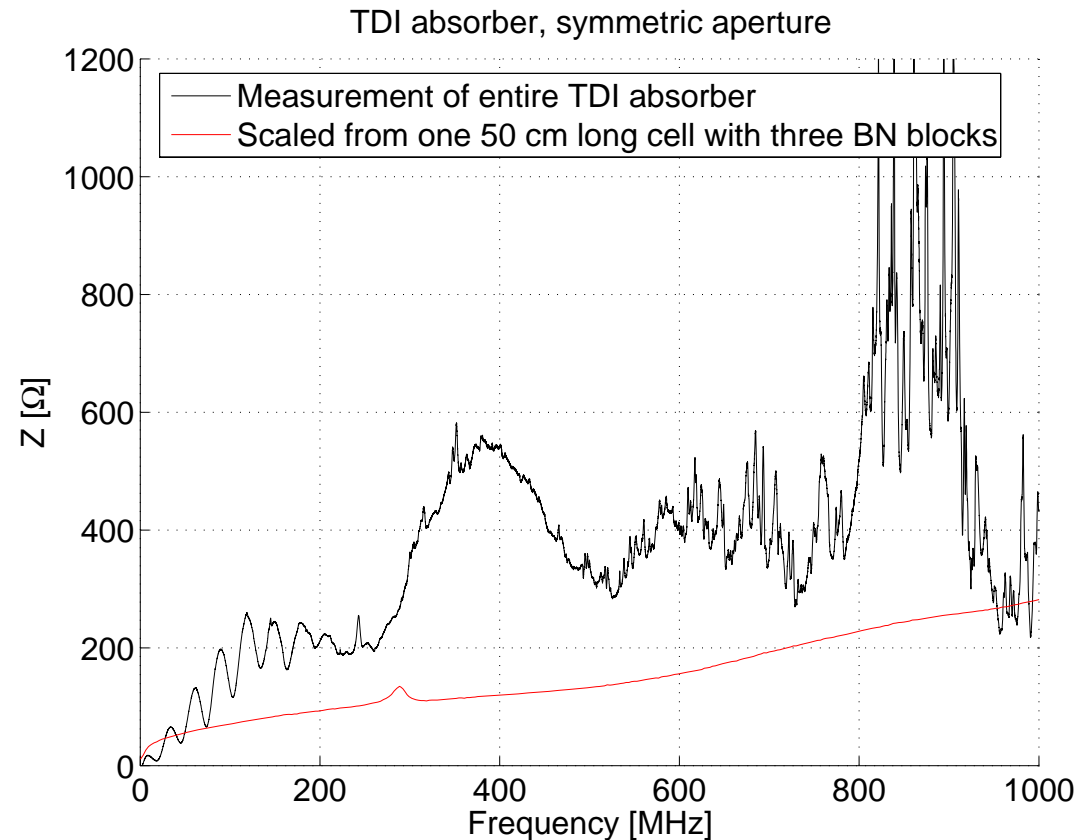

Bench versus Entire TDI - Z_Y

- ◆ For Z_Y large discrepancy between results from bench measurement and on entire TDI
- ◆ The high impedance found for the entire TDI could be due to the geometrical impedance of the discontinuities between 50 cm cells and at the ends of the jaw

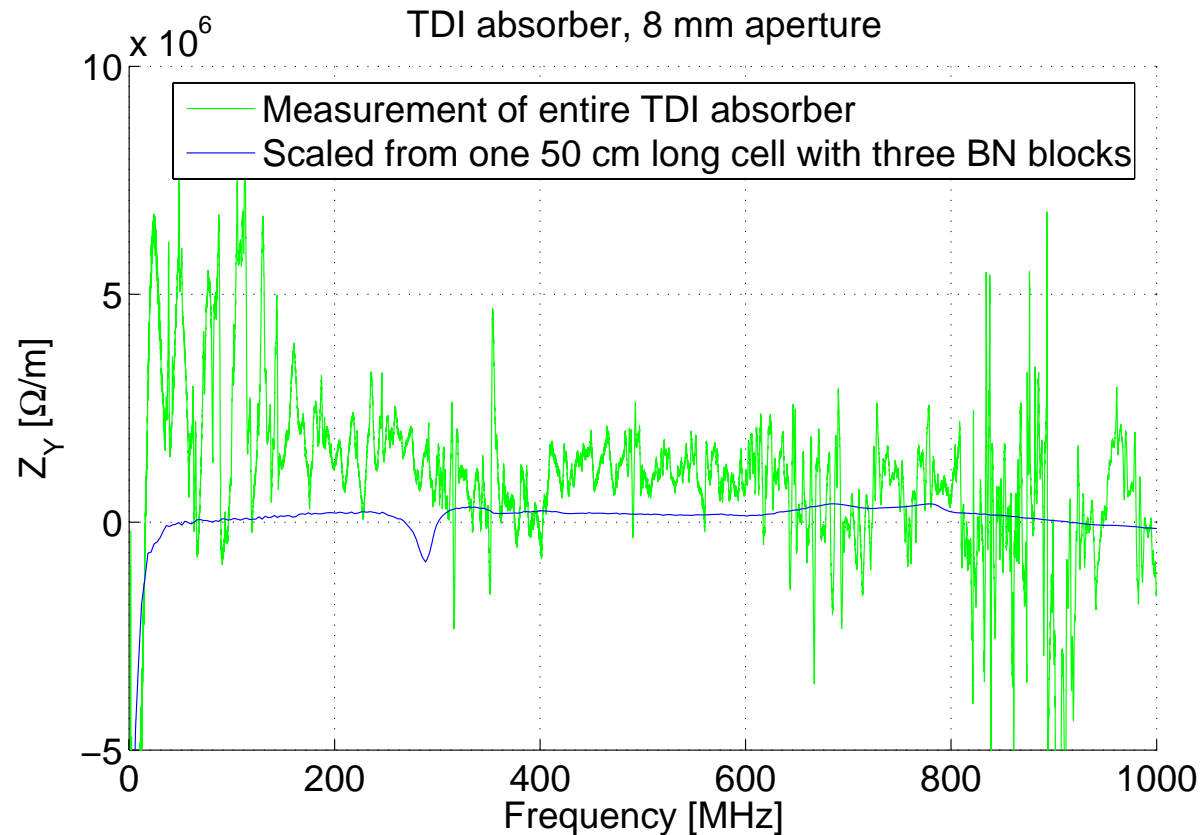

Conclusion

- ◆ On the fully assembled TDI absorber a number of rather strong longitudinal and transverse resonances were found on the TDI absorber without ferrites
- ◆ The longitudinal impedance was also higher than expected from simple scaling of the Ti coating resistance. This is probably due to the missing direct contact between absorber blocks and the gaps between the 50 cm aluminium cells. Providing RF contact at these places should help mitigate the problem
- ◆ There are indications for a high broad-band Z_Y , however the measurement uncertainties are rather large
- ◆ In bench measurements on one 50 cm long aluminium cell with Ti coated BN absorbers a much lower longitudinal and transverse impedance was found
- ◆ The high impact of transitions between absorber blocks could be pinpointed in a resonant measurement
- ◆ The discrepancies between results from bench measurements and the full TDI could be due to the 5 mm wide gaps between the 50 cm cells

Acknowledgements

- ◆ We would like to thank Oliver Aberle, Michael Owen and Wilhelmus Vollenberg for help setting up the measurements, providing data and samples of the TDI components and Elena Shaposhnikova and Trevor Linnecar for support.